

ESD-Protection Diode in SOD-523

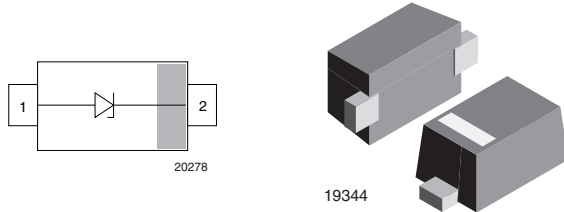

FEATURES

- Single-line ESD-protection
- Capacitance typical $C_D = 12 \text{ pF}$ ($V_R = 2.5 \text{ V}$, $f = 1 \text{ MHz}$)
- Leakage current $I_R < 1 \mu\text{A}$ ($V_R = 5 \text{ V}$)
- ESD-protection acc. IEC 61000-4-2
> 20 kV contact discharge
> 30 kV air discharge
- Non-magnetic package material
- e3 - Sn
- Compliant to RoHS directive 2002/95/EC and in accordance to WEEE 2002/96/EC

RoHS
COMPLIANT

MARKING (example only)



Bar = cathode marking
Y = type code (see table below)
X = date code

ORDERING INFORMATION

DEVICE NAME	ORDERING CODE	TAPED UNITS PER REEL (8 mm TAPE ON 7" REEL)	MINIMUM ORDER QUANTITY
VESD05A1B-02V	VESD05A1B-02V-GS08	3000	3000

PACKAGE DATA

DEVICE NAME	PACKAGE NAME	TYPE CODE	WEIGHT	MOLDING COMPOUND FLAMMABILITY RATING	MOISTURE SENSITIVITY LEVEL	SOLDERING CONDITIONS
VESD05A1B-02V	SOD-523	H	1.5 mg	UL 94 V-0	MSL level 1 (according J-STD-020)	260 °C/10 s at terminals

ABSOLUTE MAXIMUM RATINGS VESD05A1B-02V

PARAMETER	TEST CONDITIONS	SYMBOL	VALUE	UNIT
Peak pulse current	Acc. IEC 61000-4-5, 8/20 μs /single shot	I_{PPM}	3	A
Peak pulse power	Acc. IEC 61000-4-5, 8/20 μs /single shot	P_{PP}	33	W
ESD immunity	Contact discharge acc. IEC 61000-4-2; 10 pulses	V_{ESD}	± 20	kV
	Air discharge acc. IEC 61000-4-2; 10 pulses		± 30	kV
Operating temperature	Junction temperature	T_J	- 40 to + 125	°C
Storage temperature		T_{STG}	- 55 to + 150	°C

BiAs-MODE (bidirectional asymmetrical protection mode)

With the VESD05A1B-02V one signal- or data-lines (L1) can be protected against voltage transients. With pin 1 connected to ground and pin 2 connected to a signal- or data-line which has to be protected. As long as the voltage level on the data- or signal-line is between 0 V (ground level) and the specified maximum reverse working voltage (V_{RWM}) the protection diode between data line and ground offers a high isolation to the ground line. The protection device behaves like an open switch.

As soon as any positive transient voltage signal exceeds the break through voltage level of the protection diode, the diode becomes conductive and shorts the transient current to ground. Now the protection device behaves like a closed switch. The clamping voltage (V_C) is defined by the breakthrough voltage (V_{BR}) level plus the voltage drop at the series impedance (resistance and inductance) of the protection device.

Any negative transient signal will be clamped accordingly. The negative transient current is flowing in the forward direction of the protection diode. The low forward voltage (V_F) clamps the negative transient close to the ground level.

Due to the different clamping levels in forward and reverse direction the VESD05A1B-02V clamping behaviour is bidirectional and asymmetrical (BiAs).



20280

ELECTRICAL CHARACTERISTICS VESD05A1B-02V

PARAMETER	TEST CONDITIONS/REMARKS	SYMBOL	MIN.	TYP.	MAX.	UNIT
Protection paths	Number of lines which can be protected	$N_{channel}$	-	-	1	lines
Reverse working voltage	at $I_R = 1 \mu A$	V_{RWM}	5	-	-	V
Reverse current	at $V_R = 5 V$	I_R	-	0.01	0.1	μA
Reverse breakdown voltage	at $I_R = 1 mA$	V_{BR}	6	6.8	7.5	V
Reverse clamping voltage	at $I_{PP} = 1 A$	V_C	-	8	9.5	V
	at $I_{PP} = I_{PPM} = 3 A$		-	8.9	11	V
Forward clamping voltage	at $I_{PP} = 0.2 A$	V_F	-	0.95	1.2	V
	at $I_{PP} = 1 A$		-	1.3	-	V
	at $I_{PP} = I_{PPM} = 3 A$		-	1.9	-	V
Capacitance	at $V_R = 0 V$; $f = 1 MHz$	C_D	-	19	23	pF
	at $V_R = 2.5 V$; $f = 1 MHz$		-	12	-	pF

Note

- Ratings at 25 °C, ambient temperature unless otherwise specified. BiAs mode (between pin 1 and pin 2).

TYPICAL CHARACTERISTICS ($T_{amb} = 25 \text{ }^\circ\text{C}$, unless otherwise specified)

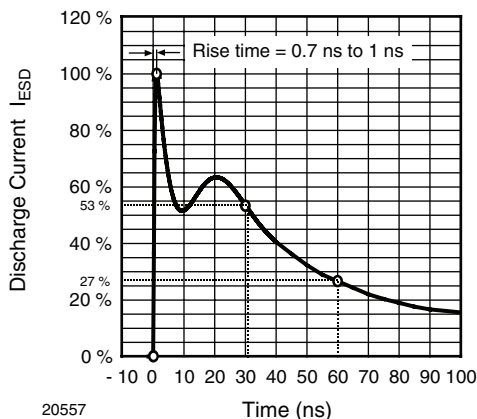

Fig. 1 - ESD Discharge Current Wave Form acc. IEC 61000-4-2 (330 Ω /150 pF)

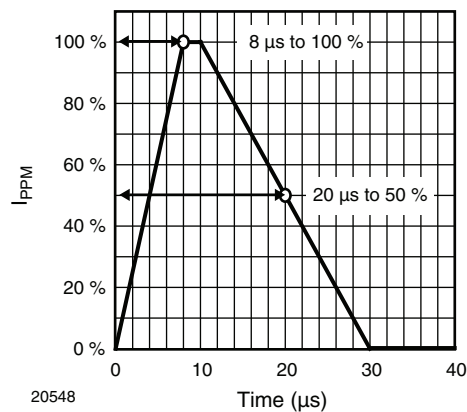

Fig. 2 - 8/20 μs Peak Pulse Current Wave Form acc. IEC 61000-4-5

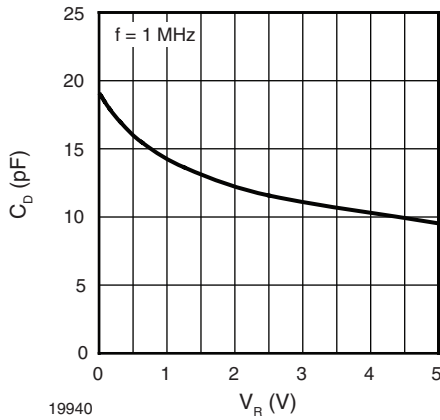
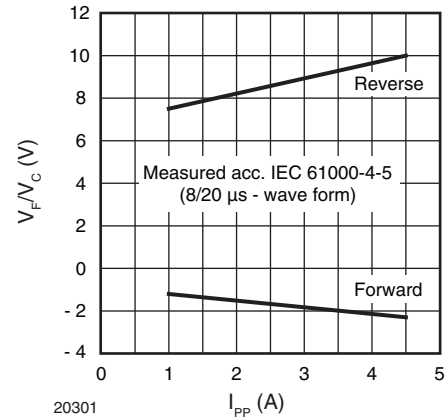
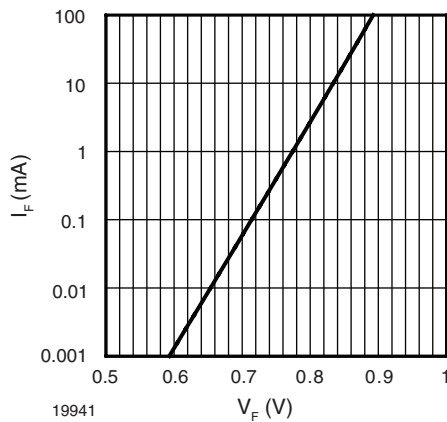
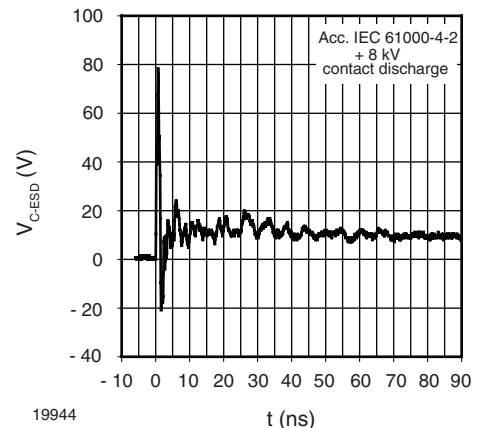

 Fig. 3 - Typical Capacitance C_D vs. Reverse Voltage V_R

 Fig. 6 - Typical Peak Clamping Voltage V_C vs. Peak Pulse Current I_{PP}

 Fig. 4 - Typical Forward Current I_F vs. Forward Voltage V_F

Fig. 7 - Typical Clamping Performance at +8 kV Contact Discharge (acc. IEC 61000-4-2)

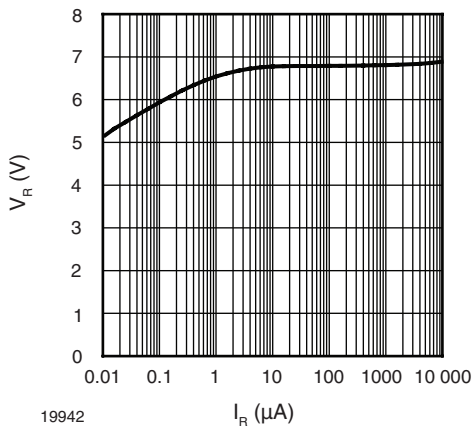
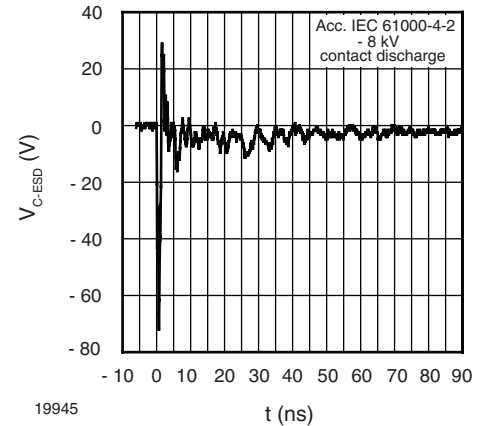

 Fig. 5 - Typical Reverse Voltage V_R vs. Reverse Current I_R

Fig. 8 - Typical Clamping Performance at -8 kV Contact Discharge (acc. IEC 61000-4-2)

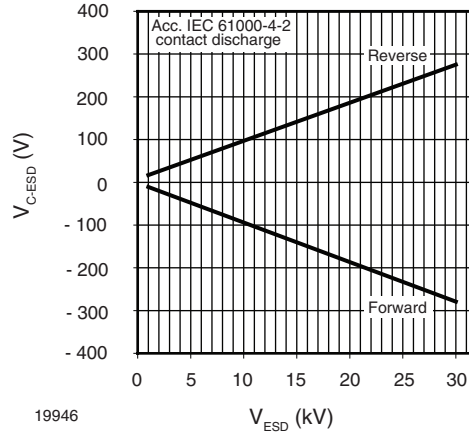
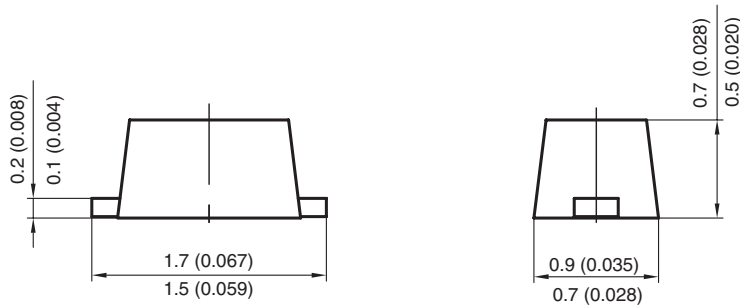
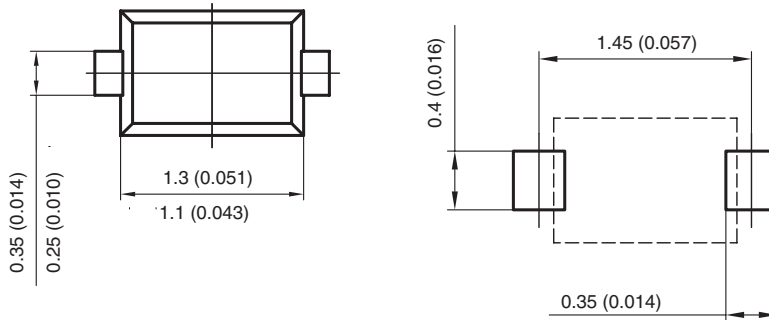

Fig. 9 - Typical Peak Clamping Voltage at \pm ESD Contact Discharge (acc. IEC 61000-4-2)

PACKAGE DIMENSIONS in millimeters (inches): **SOD-523**



Foot print recommendation:



Document no.: S8-V-3880.02-001
 Rev. f - Date: 25. January. 2005
 16864



Disclaimer

All product specifications and data are subject to change without notice.

Vishay Intertechnology, Inc., its affiliates, agents, and employees, and all persons acting on its or their behalf (collectively, "Vishay"), disclaim any and all liability for any errors, inaccuracies or incompleteness contained herein or in any other disclosure relating to any product.

Vishay disclaims any and all liability arising out of the use or application of any product described herein or of any information provided herein to the maximum extent permitted by law. The product specifications do not expand or otherwise modify Vishay's terms and conditions of purchase, including but not limited to the warranty expressed therein, which apply to these products.

No license, express or implied, by estoppel or otherwise, to any intellectual property rights is granted by this document or by any conduct of Vishay.

The products shown herein are not designed for use in medical, life-saving, or life-sustaining applications unless otherwise expressly indicated. Customers using or selling Vishay products not expressly indicated for use in such applications do so entirely at their own risk and agree to fully indemnify Vishay for any damages arising or resulting from such use or sale. Please contact authorized Vishay personnel to obtain written terms and conditions regarding products designed for such applications.

Product names and markings noted herein may be trademarks of their respective owners.